

# Milling · Fräsen

## Indexable Milling Tools · Wendeschneidplattenfräser

B

Milling Tools  
Fräser

### Applicable inserts · Wendeschneidplatten

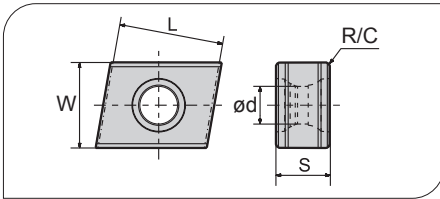

- Ideal Machining Condition / Gute Bearbeitungsbedingungen
- Normal Machining Condition / Normale Bearbeitungsbedingungen
- Unfavorable Machining Condition / Ungünstige Bearbeitungsbedingungen

Workpiece Material / Werkstoff	P	M	K	N	S	YBC301	YBC302	YBC401	YBM251	YBM253	YBM351	YBD152	YBD252	YBG102	YBG202	YBG205	YBG212	YBG152	YBG252	YNG151	YNG151C	YC30S	YD101	YD201	
P Steel / Stahl	●	●	●	●	●	●	●	●	●	●	●	●	●	●	●	●	●	●	●	●	●	●	●	●	●
M Stainless Steel / Rostfreier Stahl	●	●	●	●	●	●	●	●	●	●	●	●	●	●	●	●	●	●	●	●	●	●	●	●	●
K Cast iron / Gusseisen	●	●	●	●	●	●	●	●	●	●	●	●	●	●	●	●	●	●	●	●	●	●	●	●	●
N Non-ferrous material / Ne Metalle	●	●	●	●	●	●	●	●	●	●	●	●	●	●	●	●	●	●	●	●	●	●	●	●	●
S Heat-resistant steel / Warmfester Stahl	●	●	●	●	●	●	●	●	●	●	●	●	●	●	●	●	●	●	●	●	●	●	●	●	●

Insert WSP	Type Typ	Dimensions (mm) / Abmessungen					CVD Coating / CVD Beschicht.						PVD Coating / PVD Beschicht.				Cermets / Cermet	Carbide uncoat. / unbe. Hartmetall							
		L	W	S	R/C	ød	YBC301	YBC302	YBC401	YBM251	YBM253	YBM351	YBD152	YBD252	YBG102	YBG202		YBG205	YBG212	YBG152	YBG252	YNG151	YNG151C	YC30S	YD101
	<b>CNE121006A</b>	12.8	10.0	6.35	0.4	4.4					●	○													
	<b>CNE121006B</b>	12.0	10.0	6.35	0.6	4.4					○	●													

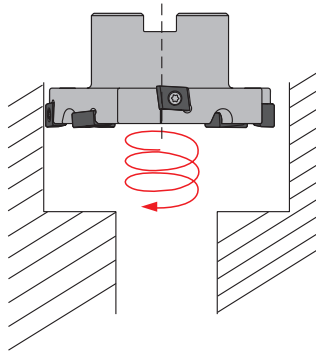

### Recommended cutting data · Empfohlene Schnittdaten

Workpiece material / Werkstückstoff	Hardness HB / Härte	Grade / Sorte	Cutting data / Schnittdaten				
			V (m/min)	f (mm/zeff)	a <sub>pmax</sub>		
					CNE121006A	CNE121006B	
<b>P</b> Low-carbon steel / Soft steel / Niedriglegierter Kohlenstoffstahl / Baustahl	≤180	YBM253	270 (220-350)	0.2 (0.15-0.3)	15-90	15-90	
	180-280	YBM253	260 (200-320)	0.2 (0.15-0.3)	15-90	15-90	
	280-350	YBM253	240 (180-300)	0.2 (0.15-0.3)	15-90	15-90	
<b>M</b> stainless steel / Edelstahl	≤270	YBM253	230 (180-300)	0.2 (0.1-0.3)	15-90	15-90	
<b>K</b> Cast iron / Gusseisen	180-250	YBD152	270 (150-300)	0.2 (0.15-0.3)	15-90	15-90	

● Ex Stock / ab Lager ○ On demand / auf Anfrage

# Milling - Fräsen

## Indexable Milling Tools - Wendepplattenfräser

### AP\*\*

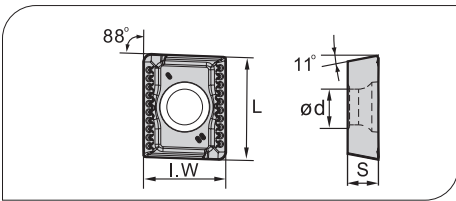

- Ideal Machining Condition / Gute Bearbeitungsbedingungen
- Normal Machining Condition / Normale Bearbeitungsbedingungen
- Unfavorable Machining Condition / Ungünstige Bearbeitungsbedingungen

Workpiece Material / Werkstoffe	P	M	K	N	S	YBC301	YBC302	YBC401	YBM251	YBM253	YBM351	YBD152	YBD252	YBG102	YBG202	YBG205	YBG302	YBG152	YBG252	YNG151	YNG151C	YC30S	YD101	YD201
P Steel / Stahl	●	●	●	●	●	●	●	●	●	●	●	●	●	●	●	●	●	●	●	●	●	●	●	●
M Stainless Steel / Rostfreier Stahl		●	●	●	●																			
K Cast iron / Gusseisen			●																					
N Non-ferrite material / Ne Metalle				●																				
S Heat-resistant steel / Warmfester Stahl					●																			

Insert WSP	Type Typ	Dimensions (mm) / Abmessungen					CVD Coating / CVD Beschicht.						PVD Coating / PVD Beschicht.				Cermet / Cermet	Carbide uncoat. / unbe. Hartmetall						
		L	I.W	S	d	r	YBC301	YBC302	YBC401	YBM251	YBM253	YBM351	YBD152	YBD252	YBG102	YBG202		YBG205	YBG302	YBG152	YBG252	YNG151	YNG151C	YC30S
	APKT150412-PM	16.33	12.7	4.76	5.4	1.2					●							●						
	APKT150412-KM	16.33	12.7	4.76	5.4	1.2												○	●					

### CN

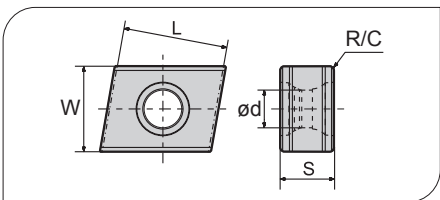

- Ideal Machining Condition / Gute Bearbeitungsbedingungen
- Normal Machining Condition / Normale Bearbeitungsbedingungen
- Unfavorable Machining Condition / Ungünstige Bearbeitungsbedingungen

Workpiece Material / Werkstoffe	P	M	K	N	S	YBC301	YBC302	YBC401	YBM251	YBM253	YBM351	YBD152	YBD252	YBG102	YBG202	YBG205	YBG302	YBG152	YBG252	YNG151	YNG151C	YC30S	YD101	YD201
P Steel / Stahl	●	●	●	●	●	●	●	●	●	●	●	●	●	●	●	●	●	●	●	●	●	●	●	●
M Stainless Steel / Rostfreier Stahl		●	●	●	●																			
K Cast iron / Gusseisen			●																					
N Non-ferrite material / Ne Metalle				●																				
S Heat-resistant steel / Warmfester Stahl					●																			

Insert WSP	Type Typ	Dimensions (mm) / Abmessungen					CVD Coating / CVD Beschicht.						PVD Coating / PVD Beschicht.				Cermet / Cermet	Carbide uncoat. / unbe. Hartmetall						
		L	W	S	R/C	ød	YBC301	YBC302	YBC401	YBM251	YBM253	YBM351	YBD152	YBD252	YBG102	YBG202		YBG205	YBG302	YBG152	YBG252	YNG151	YNG151C	YC30S
	CNE121006A	12.8	10.0	6.35	0.4	4.4					●		○											
	CNE121006B	12.0	10.0	6.35	0.6	4.4						○	●											

● Ex Stock / ab Lager    ○ On demand / auf Anfrage

Comparison table for milling Insert - Grades  
Fräswendepplatten Übersichtstabelle - Sorten

Workpiece material Workpiece material	ISO	Coatet carbide Beschichtetes Hartmetall		Cermet Cermet	Uncoatet carbide unbeschichtetes Hartmetall	PCBN & PCD PCBN & PKD
		CVD	PVD			
<b>P</b> Steel Stahl	P01					
	P10		YBG202	YNG151	YNG151C	
	P20	YBC301 YBC302 YBM251 YBM253	YBG202	YNG151	YNG151C	
	P30	YBM351 YBC401			YC30S	
	P40		YBG302			
<b>M</b> Stainless Steel Rostfreier Stahl	M01					
	M10	YBM251	YBG202	YNG151	YNG151C	
	M20	YBM253	YBG205			
	M30	YBM351	YBG252			
	M40		YBG302		YC30S	
<b>K</b> Cast iron Grauguss	K01					
	K10	YBD152	YBG102	YNG151	YNG151C	
	K20					YD201
	K30	YBD252	YBG152			
	K40					
<b>N</b> Hardened material Gehärtete Werkstoffe	N01					
	N10				YD101	
	N20					YD201
	N30					
<b>S</b> Heat-resistant steel Warmfester Stahl	S01					
	S10		YBG202			
	S20	YBM253				
	S30					
<b>H</b> Non-ferrous materials Ne Metalle	H01					
	H10					
	H20					
	H30					

# Coated Cemented Carbide **CVD** Beschichtetes Hartmetall

Grade Sorte	Coating Beschicht.	Micro-Structure Micro-Struktur	ISO	Application Anwendung
<b>YBC301</b>	Substrate with high strength, in combination with MT-Ti(CN), thin layer Al <sub>2</sub> O <sub>3</sub> and TiN Coating. Beschichtetes Hartmetall mit hoher Schneidkanten-sicherheit. In Kombination mit TiCN Al <sub>2</sub> O <sub>3</sub> , und TiN.		<b>P15~35</b>	Suitable for light and medium milling of low alloy steel and non alloy steel, even under unfavorable condition. Gut geeignet für leichte bis mittlere Fräsbearbeitung von niedriglegierten Stählen unter schwierigen Bedingungen.
<b>YBC302</b> <i>New!</i>	Substrate with high strength in combination with CVD coating of MT-Ti(CN) and Al <sub>2</sub> O <sub>3</sub> in fine grain size and stable structure. Substrat mit hoher Festigkeit in Kombination mit CVD-beschichtete MT-Ti(CN) und Al <sub>2</sub> O <sub>3</sub> in feinkörnigem und stabilem Struktur.		<b>P15~35</b>	High performance in milling of alloy steel and casting steel. Fräsen von legiertem Stahl und Gussstahl mit hoher zerspannleistung.
<b>YBC401</b>	Substrate with excellent toughness, in combination with CVD coating of Ti(CN), thin layer Al <sub>2</sub> O <sub>3</sub> , TiN. CVD beschichtetes Hartmetall mit guter Zähigkeit.		<b>P25~50</b> <b>M20~40</b>	It is suitable for medium to heavy milling steels and stainless steel. Zum Fräsen von Stahl und rostfreiem Stahl in ungünstiger Bearbeitungsbedingung.
<b>YBM251</b>	Substrate with good toughness and strength, in combination with Ti(CN), thin layer Al <sub>2</sub> O <sub>3</sub> , TiN. Universal einsetzbare CVD-beschichtete Hartmetallsorte aus TiN +MT-TiCN + dünner Al <sub>2</sub> O <sub>3</sub> + TiN mit guter Zähigkeit und Verschleißfestigkeit.		<b>P15~40</b> <b>M10~30</b>	Good performance in milling of alloy steel and stainless steel. Gute Leistung beim Fräsen von legiertem und rostfreiem Stahl.
<b>YBM253</b> <i>New!</i>	Carbide substrate with good toughness and strength, in combination with CVD coating of MT-Ti(CN) and Al <sub>2</sub> O <sub>3</sub> in fine grain size and stable structure. Hartmetall mit guter Zähigkeit und Festigkeit in Kombination mit CVD beschichtete MT-Ti(CN) und Al <sub>2</sub> O <sub>3</sub> in feinkörnigem und stabilem Struktur.		<b>P20~40</b> <b>M10~30</b> <b>S10~30</b>	Universal grade for milling of steel, stainless steel and difficult material. Universal einsetzbar Sorte für Fräsen von Stahl, rostfreiem Stahl und schwierige Material.
<b>YBM351</b>	MT-TiCN+Al <sub>2</sub> O <sub>3</sub> coated carbide grade with very good strength and impact resistance. Beschichtete Hartmetallsorte MT-TiCN+Al <sub>2</sub> O <sub>3</sub> mit ausgezeichneter Widerstandsfähigkeit und Schneidkantensicherheit.		<b>P25~40</b> <b>M20~40</b>	It is for milling of steel, alloy steel and stainless steel. Zum Fräsen von Stahl, legiertem und rostfreiem Stahl
<b>YBD152</b>	Hard medium grain Substrate in combination with TiCN, thick Al <sub>2</sub> O <sub>3</sub> coating. Hartes mittel-feinkörniges Substrat mit TiCN, dicker Al <sub>2</sub> O <sub>3</sub> Beschichtung.		<b>K05~25</b>	It is suitable for machining of gray cast iron and nodular cast iron under normal cutting conditions from low to moderate cutting speeds. Bearbeitung von Guss und Kugelgraphitguss mit niedrigen bis mittleren Schnittgeschwindigkeiten.
<b>YBD252</b>	Tough K-substrate in combination with TiN, TiCN, thick Al <sub>2</sub> O <sub>3</sub> coating. For milling of cast iron and alloy steel. Zähes K-Substrat mit TiCN, dicke Al <sub>2</sub> O <sub>3</sub> Beschichtung.		<b>K15~35</b>	For milling of cast iron and alloy steel. Zum Fräsen von Guss und legiertem Stahl.

**B**

Milling Tools  
Fräser

## Coated Cemented Carbide **PVD** Beschichtetes Hartmetall

# B

Milling Tools  
Fräser

Grade Sorte	Coating Beschicht.	ISO	Application Anwendung
<b>YBG102</b>	PVD nano-TiAlN coated fine grain hard carbide grade.	<b>K05~K20</b>	For light milling of cast iron, hard steel.
	Nano-TiAlN PVD-beschichtete, feinkörnige Hartmetallsorte.		Zum Schlichtfräsen von Guss und gehärtetem Stahl.
<b>YBG202</b>	PVD nano-TiAlN coated fine grain hard carbide grade. Good performance in combination of toughness and wear resistance.	<b>P10~30</b>	Milling of steel, finishing and semi-finishing of stainless steel, and high-temperature alloys .
		<b>M10~30</b>	
	Nano-TiAlN PVD-beschichtete, feinkörnige Hartmetallsorte. Hervorragende Kombination von Zähigkeit und Verschleißfestigkeit.	<b>S05~20</b>	Zum Fräsen von Stahl, rostfreiem Stahl und warmfesten Superlegierungen bei leichter und mittlerer Bearbeitung.
<b>YBG205</b>	Special PVD nano-TiAlN coated fine grain hard carbide grade. Good performance in combination of toughness and wear resistance.	<b>M10~30</b>	Milling of steel, finishing and semi-finishing of stainless steel.
	Spezielle Nano-TiAlN PVD-beschichtete, feinkörnige Hartmetallsorte. Hervorragende Kombination von Zähigkeit und Verschleißfestigkeit.		Zum Fräsen von rostfreiem Stahl bei leichter und mittlere Bearbeitung
<b>YBG302</b>	Substrate with reasonable hardness and strength + Nano-TiAlN PVD coating Substrate mit guter Härte und Festigkeit + Nano-TiAlN PVD Beschichtung.	<b>P25~P40</b>	For rough and semi-finish milling of steel and stainless steel.
		<b>M25~40</b>	Anwendung für mittlere und Schruppbearbeitung von Stahl, und rostfreiem Stahl.
<b>YBG152</b>	Substrate with medium hardness and strength + Nano-TiAlN PVD coating Substrate mit mittlerer Härte und Festigkeit + Nano-TiAlN PVD Beschichtung	<b>K 20~35</b>	Applicable for rough and semi-finish milling of cast iron.
			Anwendung für Schrupp- und mittlere Bearbeitung. von Guss.
<b>YBG252</b>	Ultra fine carbide substrate plus nano-TiAlN PVD coating with high strength, toughness and wear resistance.	<b>P05~20</b>	Special for finishing of alloy steel, stainless steel and cast iron.
		<b>M05~20</b>	
	Ultra-Feinkorn-Hartmetall plus Nano-TiAlN PVD-Beschichtung mit guter Zähigkeit und Verschleißfestigkeit.	<b>K05~K20</b>	Speziell zum Schlichten von legiertem Stahl, rostfreiem Stahl und Guss.

### Cermet Cermet

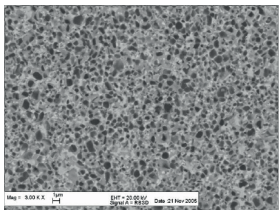
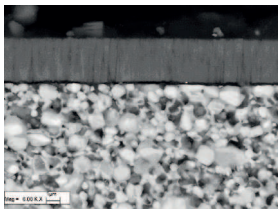
Grade Sorte	Micro-Structure Micro-Struktur	ISO	Application Anwendung
<b>YNG151</b>		P05~20	Applicable for finishing P, M & K ISO Code Anwendung für die Schlichtbearbeitung P,M und K ISO Anwendungsbereich
		M05~20	
		K05~20	
<b>YNG151C</b>		P01~20	Applicable for finish milling P, M and K ISO Code Anwendung für die Schlichtbearbeitung P,M und K ISO Anwendungsbereich
		M01~20	
		K01~20	

#### Application Anwendung

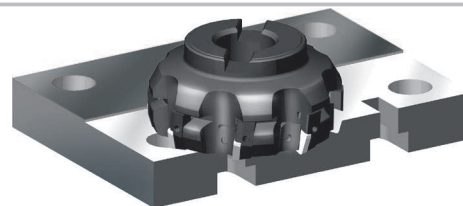
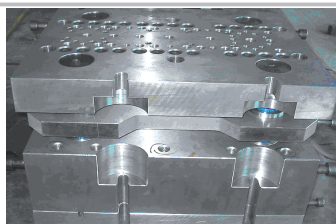

Machine Maschine	Machining center, dry cutting Bearbeitungscenter, Trockenbearbeitung	Machining center, dry cutting Bearbeitungscenter, Trockenbearbeitung
Workp. material & hardness Werkstückstoff & Härte	45 steel HB 170~220 Stahl	NAK80* HRC42~48
Type of machining Bearbeitung	Face milling finishing Schlichtfräsen	Face milling finishing Schlichtfräsen
Milling tool Fräswerkzeug	FMA03-160-B40-SE12-08	FME03-160-B40-SP12-10
Applicable insert Fräsplatte	YNG151/SEEN1203AFTN	YNG151C/SPEN1203EDER
Cutting data Schnittdaten	Vc=400m/min, fz=0.1mm/z, ap=0.3mm	Vc=420m/min, fz=0.12mm/z, ap=0.35mm

#### Application results Ergebnis

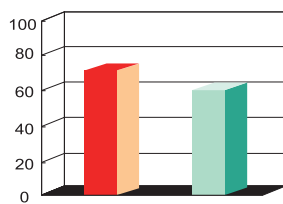

Number of workpiece machined  
Anzahl der Werkstücke

ZCC-CT Competitor  
Wettbewerber

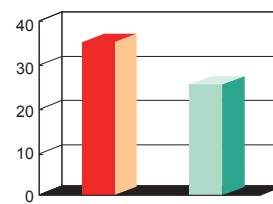

Number of workpiece machined  
Anzahl der Werkstücke

ZCC-CT Competitor  
Wettbewerber

## Uncoated Carbide unbeschichtetes Hartmetall

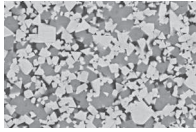
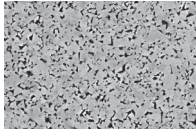
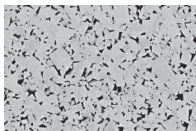
Grade Sorte	Micro-Structure Micro-Struktur	ISO	Application Anwendung
<b>YC30S</b>		<b>P25~40</b>	Applicable for roughing ISO Code P, M
		<b>M25~40</b>	Anwendung für die Schruppbearbeitung ISO Anwendungsbereich P & M.
<b>YD101</b>		<b>N05~25</b>	Applicable for semi-finish and finish milling type ISO Code N. Anwendung für die Mittlere bis Feinbearbeitung ISO Anwendungsbereich N.
<b>YD201</b>		<b>K15~35</b>	Applicable for rough and semi-finish ISO Code K, and for semi-finish ISO Code N.
		<b>N15~30</b>	Anwendung für die mittlere bis Schrupp- Bearbeitung ISO Anwend. K und für die mittlere bearbeitung N ISO Anwendung.

### Application Anwendung

Component  
Werkstück

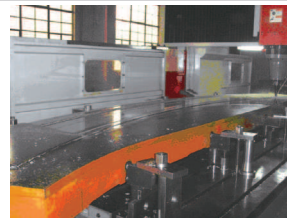
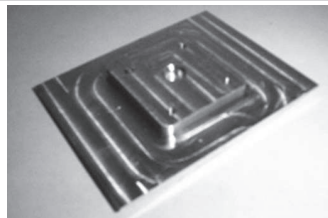

Machine  
Maschine

Verti. machining center, wet machining  
Vertikales Bearbeitungszentrum, Kühlmittel

Face milling machine, wet machining  
Planfräsmaschine, Kühlmittel

Face milling machine, dry cutting  
Planfräsmaschine,  
Trockenbearbeitung

Workp. material & hardn.  
Werkstückstoff & Härte

Aluminum alloy HB100  
Aluminum Leg.

40CrMnMo HB240

HT250 HB220

Type of machining  
Bearbeitung

Face milling  
Planfräser

Face milling  
Planfräser

Face milling  
Planfräser

Milling tool  
Fräs Werkzeug

FMA01-100-B32-SE12-07

FMP01-100-B32-TP22-06

FME03-160-B40-SP15-10

Applicable insert  
Fräsplatte

YD101/SEET12T3-LH

YC30S/TPKN2204PDR

YD201/SPKN1504EDTR

Cutting data  
Schnittdaten

$V_c=300-350\text{m/min}$ ,  $a_p=1-2\text{mm}$ ,  
 $f_z=0.2\text{mm/z}$

$V_c=170\text{m/min}$ ,  $a_p=5-7\text{mm}$ ,  
 $f_z=0.3\text{mm/z}$

$V_c=100-130\text{m/min}$ ,  $a_p=7\text{mm}$ ,  
 $f_z=0.35\text{mm/z}$

Application results  
Ergebnis

