



Tipo (grandezza) morsa / Vise (type) size	kN	1		2				3	
		25 kN		25 kN				30 kN	
Apertura massima / Maximum opening	A	2 x 16	2 x 66	2 x 54	2 x 104	2 x 154	2 x 204	2 x 74	2 x 124
	B	25		30				40	
	C	70		90				100	
	D	232	332	300	400	500	600	400	500
	E	252	352	320	420	520	620	425	525
	G	75		95				125	
	J	56		64				84	
	W	74		94				124	
kg		9	12	22	29	35	42	44	49

**3 MORSE IN UNA
VISES IN ONE**



Art. 860

Art. 855 + Art. 805C + n. 2 Art. 810

Cod.	5.86.01200	5.86.01300	5.86.02300	5.86.02400	5.86.02500	5.86.02600	5.86.03400	5.86.03500
------	------------	------------	------------	------------	------------	------------	------------	------------

SPECIAL PRICE

Art. 860D (Art. 860 + 802) Morsa + moltiplicatore di coppia / Vise + torque multiplier

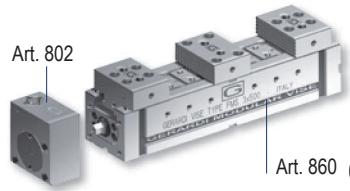

Cod.	5.86.0D120	5.86.0D130	5.86.0D230	5.86.0D240	5.86.0D250	5.86.0D260	5.86.0D340	5.86.0D350
------	------------	------------	------------	------------	------------	------------	------------	------------

Art. 860 (Art. 855 + Art. 805C + n. 2 Art. 810)

Art. 860E (Art. 860 + 890) Morsa + motore idraulico / Vise + hydraulic motor

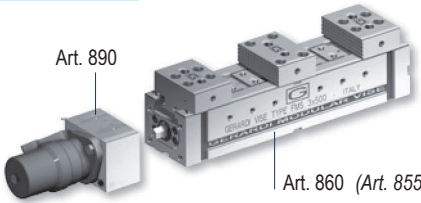

Cod.	5.86.0E120	5.86.0E130	5.86.0E230	5.86.0E240	5.86.0E250	5.86.0E260	5.86.0E340	5.86.0E350
------	------------	------------	------------	------------	------------	------------	------------	------------

Art. 860 (Art. 855 + Art. 805C + n. 2 Art. 810)

Art. 860F (Art. 860 + 890 + 266B) Morsa + motore idraulico + centralina / Vise + hydraulic motor + power unit

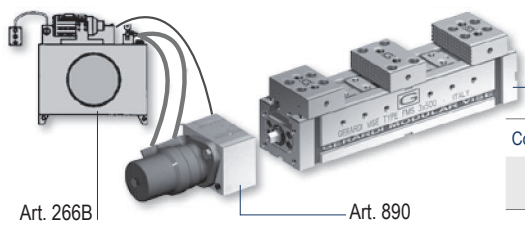

Cod.	5.86.0F120	5.86.0F130	5.86.0F230	5.86.0F240	5.86.0F250	5.86.0F260	5.86.0F340	5.86.0F350
------	------------	------------	------------	------------	------------	------------	------------	------------

Art. 860 (Art. 855 + Art. 805C + n. 2 Art. 810)

Art. 860

Morsa doppia, singola, autocentrante con ganasce piane / Double, single, self-centering vise with straight jaws

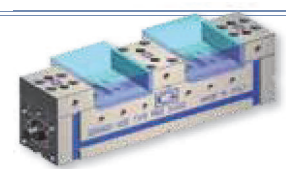

Dotazione standard:

- 2 arresti laterali Art. 370
- 1 coppia di tasselli di posizionamento precisi Art. 297
- 1 chiave a pipa Art. 375
- 1 piastrina di collegamento Art.801S

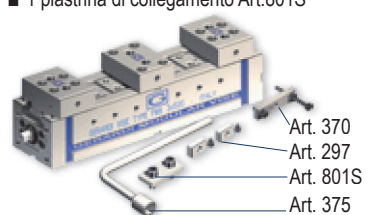

Standard equipment:

- 2 workstops Art. 370
- 1 pair of precision positioning key-nuts Art. 297
- 1 box wrench Art. 375
- 1 connecting plate Art.801S

Art. 855
Corpo base
Base body

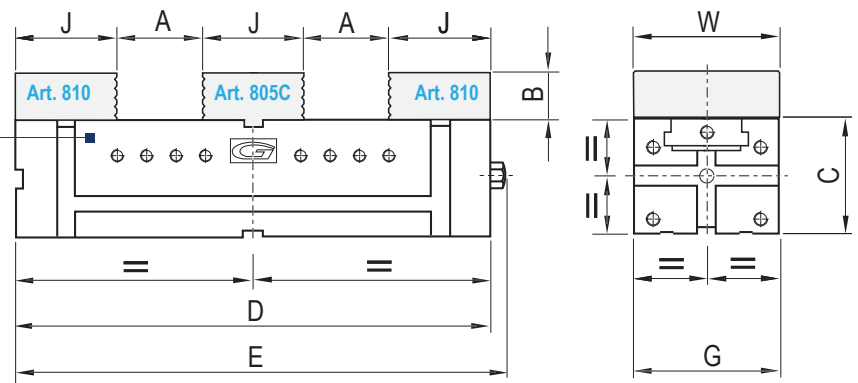



3 30 kN			4 30 kN				5 32 kN			6 32 kN		
2 x 174	2 x 224	2 x 274	2 x 103	2 x 153	2 x 203	2 x 253	2 x 138	2 x 188	2 x 238	2 x 238	2 x 288	2 x 338
40			50				60			60		
100			120				140			160		
600	700	800	500	600	700	800	600	700	800	800	900	1000
625	725	825	525	625	725	825	625	725	825	825	925	1025
125			145				170			190		
84			98				108			108		
124			144				169			189		
54	59	64	71	79	88	96	130	140	150	210	230	250
5.86.03600	5.86.03700	5.86.03800	5.86.04500	5.86.04600	5.86.04700	5.86.04800	5.86.05600	5.86.05700	5.86.05800	5.86.06800	5.86.06900	5.86.06100

SPECIAL PRICE

Art. 860D

(Art. 860 + 802) Morsa + moltiplicatore di coppia / Vise + torque multiplier

5.86.0D360	5.86.0D370	5.86.0D380	5.86.0D450	5.86.0D460	5.86.0D470	5.86.0D480	5.86.0D560	5.86.0D570	5.86.0D580	5.86.0D680	5.86.0D690	5.86.0D610
------------	------------	------------	------------	------------	------------	------------	------------	------------	------------	------------	------------	------------

Art. 860E

(Art. 860 + 890) Morsa + motore idraulico / Vise + hydraulic motor

5.86.0E360	5.86.0E370	5.86.0E380	5.86.0E450	5.86.0E460	5.86.0E470	5.86.0E480	5.86.0E560	5.86.0E570	5.86.0E580	5.86.0E680	5.86.0E690	5.86.0E610
------------	------------	------------	------------	------------	------------	------------	------------	------------	------------	------------	------------	------------

Art. 860F

(Art. 860 + 890 + 266B) Morsa + motore idraulico + centralina / Vise + hydraulic motor + power unit

5.86.0F360	5.86.0F370	5.86.0F380	5.86.0F450	5.86.0F460	5.86.0F470	5.86.0F480	5.86.0F560	5.86.0F570	5.86.0F580	5.86.0F680	5.86.0F690	5.86.0F610
------------	------------	------------	------------	------------	------------	------------	------------	------------	------------	------------	------------	------------

Art. 860

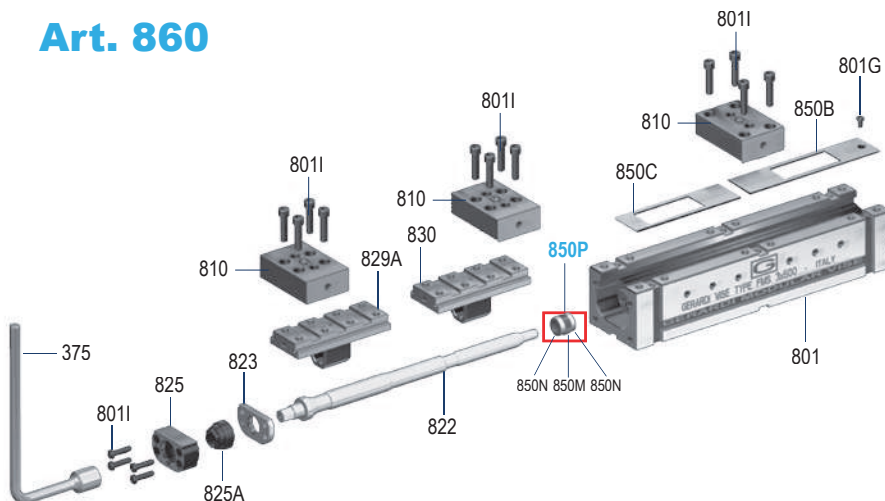

Art.	Pag.	Art.	Pag.
375	4.27	850B	5.54
801	5.40	850C	5.54
801G	5.54	-	-
801I	5.54	-	-
805C	5.49	-	-
822	5.46	-	-
823	5.52	-	-
825	5.52	-	-
825A	5.54	-	-
829A	5.44	-	-
830	5.44	-	-