

Tipo (grandezza) morsa / Vise (type) size

1 2 3 4 5 6

**Art. 391**

N° 1 serraggio  
N° 1 clamping

**MORSA NON COMPRESA**  
**WISE NOT INCLUDED**

**Art. 395 + Art. 271 + Art. 403 (m 1,5)**

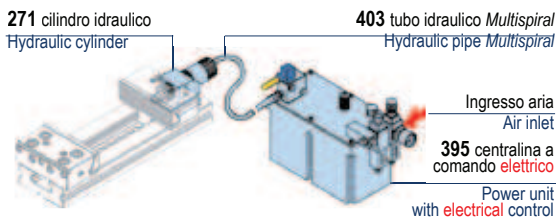

Cod. 4.39.11000 4.39.12000 4.39.13000 4.39.14000 4.39.15000 4.39.16000

**Art. 391 / 2**

N° 2 serraggi contemporanei  
N° 2 simultaneously clamping

**Art. 391 + n° 1 Art. 271**

+ 1 Art. 271

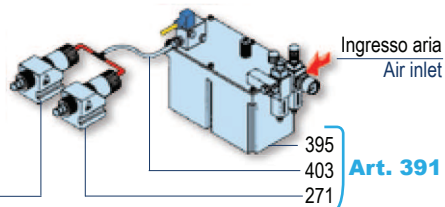

Cod. 4.39.11002 4.39.12002 4.39.13002 4.39.14002 4.39.15002 4.39.16002

**Art. 391 / 3**

N° 3 serraggi contemporanei  
N° 3 simultaneously clamping

**Art. 391 + n° 2 Art. 271**

+ 2 Art. 271

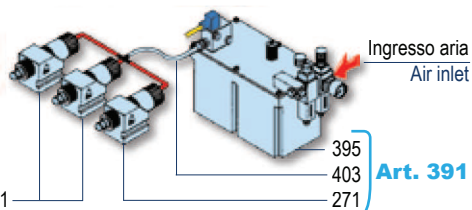

Cod. 4.39.11003 4.39.12003 4.39.13003 4.39.14003 4.39.15003 4.39.16003

**Art. 391 / 4**

N° 4 serraggi contemporanei  
N° 4 simultaneously clamping

**Art. 391 + n° 3 Art. 271**

+ 3 Art. 271

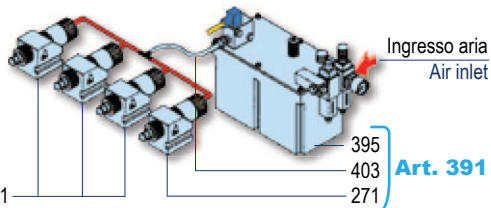

Cod. 4.39.11004 4.39.12004 4.39.13004 4.39.14004 4.39.15004 4.39.16004

**Art. 407A**

Gruppo di serraggio indipendente  
Independent clamping group

**Art. 271 + Art. 398 + Art. 403 (m 1,5)**

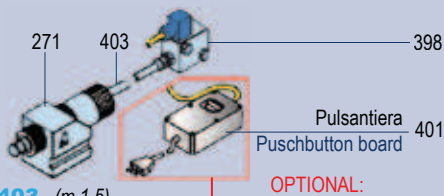

Cod. 4.40.7A100 4.40.7A200 4.40.7A300 4.40.7A400 4.40.7A500 4.40.7A600

**Art. 391A / 2**

N° 2 serraggi indipendenti  
N° 2 independent clamping

**Art. 391 + n° 1 Art. 407A**

+ 1 Art. 407A

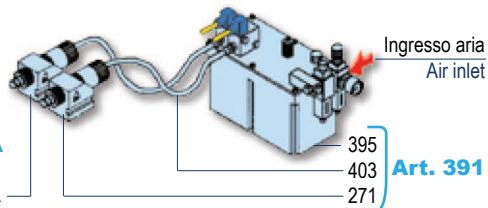

Cod. 4.39.1A102 4.39.1A202 4.39.1A302 4.39.1A402 4.39.1A502 4.39.1A602

**Art. 391A / 3**

N° 3 serraggi indipendenti  
N° 3 independent clamping

**Art. 391 + n° 2 Art. 407A**

+ 2 Art. 407A

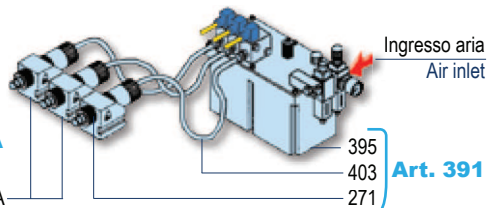

Cod. 4.39.1A103 4.39.1A203 4.39.1A303 4.39.1A403 4.39.1A503 4.39.1A603

**Art. 391A / 4**

N° 4 serraggi indipendenti  
N° 4 independent clamping

**Art. 391 + n° 3 Art. 407A**

+ 3 Art. 407A

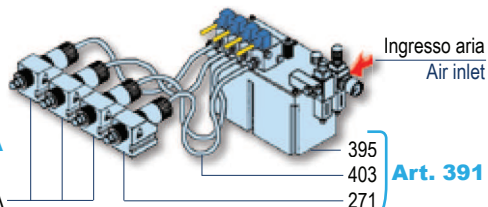

Cod. 4.39.1A104 4.39.1A204 4.39.1A304 4.39.1A404 4.39.1A504 4.39.1A604

4

**ISTRUZIONI**
**CENTRALINA OLEOPNEUMATICA**

La centralina per serraggi idraulici ed i suoi derivati, nasce per soddisfare tutte le esigenze connesse all'azionamento di cilindri oleodinamici ove sia richiesta bassa portata ed elevate pressioni. La particolare forma costruttiva della centralina permette di ottenere, in ingombri estremamente contenuti, un impianto di elevate prestazioni. L'elemento pompante utilizzato consente, grazie ai particolari criteri costruttivi, di collocare la centralina in ambienti altamente ostili come, per esempio, l'area di lavoro di macchine utensili. L'esclusivo sistema modulare di controllo del flusso idraulico permette di comandare separatamente, con una sola unità, fino a sei utilizzi distinti.

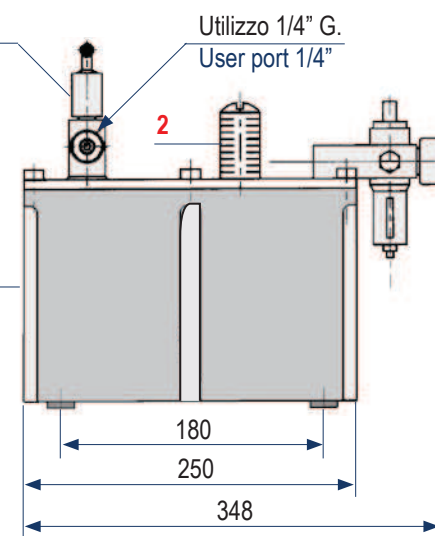
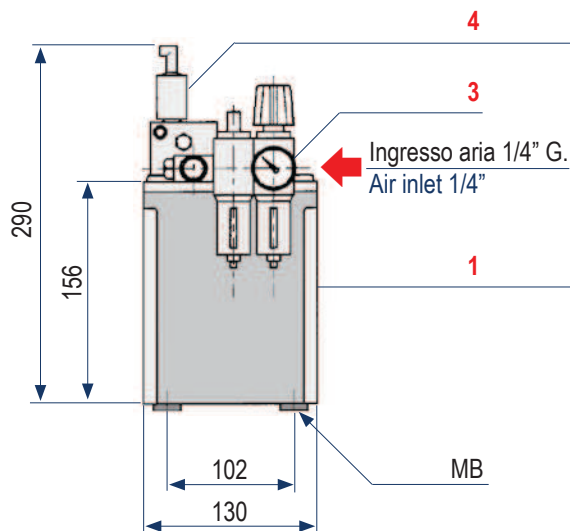
**INSTRUCTIONS**
**HYDROPNEUMATIC POWER UNIT**

The hydropneumatic power unit for hydraulic clamping devices and its bi-products are designed to meet all needs regarding the powering of hydraulic cylinders where low flow rates and high pressures are required. The special design shape of the power unit is such that a high performance system can be implemented taking up very little space. Thanks to the special design principles, the pump section adopted allows the hydropneumatic power unit to be installed in very hostile environments, such as the work area of machine tools, etc. The unique modular hydraulic flow control system allows controlling up to 6 separate users from just the one power unit.

**CARATTERISTICHE TECNICHE**
**SPECIFICATION**
**Centralina tipo / Power unit type 450 T 2/3/4**

Pressione massima aria: Max permissible air pressure:	7 bar
Pressione aria consigliata: Recommended air pressure:	5,5 bar
Tipo di olio raccomandato: idraulico Recommended grade of oil: hydraulic	68 CSt
Portata Deliveries	0,06 L / 1' Litres / min
Capacità serbatoio Tank capacity	3 L
Delta massimo su pilotaggi elettrici: Max delta on electric pilot section:	+ 10% - 5%
Pressione minima su pilotaggio pneumatico: Minimum pressure on pneumatic control:	5 bar
Pressione massima consentita per eventuale pilotaggio elettroidraulico: Max pressure for electrohydraulic control:	150 bar
Numero massimo condigliato di utilizzi: Max permissible air pressure	6

La pompa nella versione base viene fornita completa di:

- serbatoio in teflon **1**
- tappo di carica
- silenziatore **2**
- attacco di alimentazione aria del tipo ad innesto rapido D8 **3**
- un blocco di comando oleodinamico **4**

The pump in its basic version is supplied complete with:

- teflon tank **1**
- fill plug
- silencer **2**
- quick acting air connector fitting type D8 **3**
- hydraulic control block **4**

Pressione uscita olio - bar  
Oil outlet pressure - bar

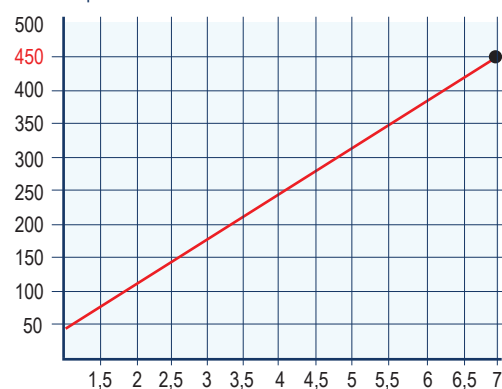

450 bar (1 bar = 14,5 psi) Pressione entrata aria - bar  
Air inlet pressure - bar

**SERRAGGIO IDRAULICO**
**HYDRAULIC CLAMPING**

 TRAMITE GRUPPI DI SERRAGGIO PNEUMATICI  
 E OLEODINAMICI

 THROUGH PNEUMO-HYDRAULIC AND HYDRAULIC  
 CLAMPING DEVICES

I diagrammi seguenti consentono di determinare le forze di serraggio ottenibili con le morse di varia grandezza (da 1 a 6), provvisti di vari dispositivi di bloccaggio idraulici, in funzione della pressione dei fluidi (aria e olio)

The following diagrams give the clamping force that can be obtained with each vise type (size 1 to 6) when equipped with hydraulic blocking devices, as a function of the fluid pressure (air or oil)

**MORSE MODULARI TIPO 1**  
**MODULAR VISES TYPE 1**

 Cilindro idraulico Art. 285 - 568 - 569  
 Ø interno 20 mm - Superficie efficace 3 cm<sup>2</sup>  
 Hydraulic cylinder Art. 285 - 568 - 569  
 Cylinder I.D. 20 mm - Effective area 3 cm<sup>2</sup>
**MORSE MODULARI TIPO 2-3-4**  
**MODULAR VISES TYPE 2-3-4**

 Cilindro idraulico Art. 285 - 568 - 569  
 Ø interno 30 mm - Superficie efficace 7 cm<sup>2</sup>  
 Hydraulic cylinder Art. 285 - 568 - 569  
 Cylinder I.D. 30 mm - Effective area 7 cm<sup>2</sup>

 Con moltiplicatore di pressione Art. 393 (Tipo 450)  
 With pressure multiplier Art.393 (Type 450)

 Con moltiplicatore di pressione Art. 393 (Tipo 450)  
 With pressure multiplier Art.393 (Type 450)

Pressione entrata aria bar / Air inlet pressure bar

Pressione entrata aria bar / Air inlet pressure bar

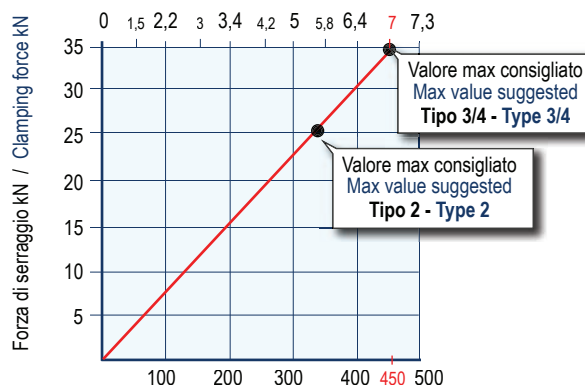
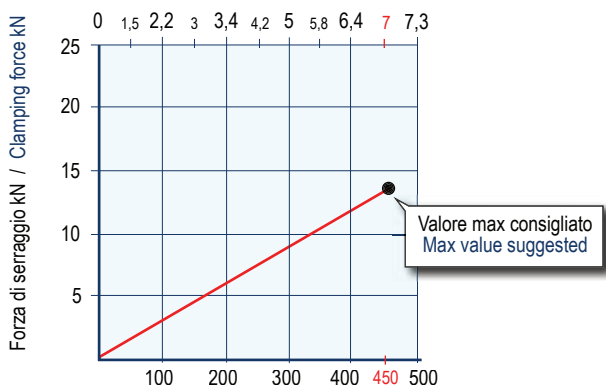
 Pressione uscita olio bar / Oil outlet pressure bar  
 (1 bar = 14,5 psi)

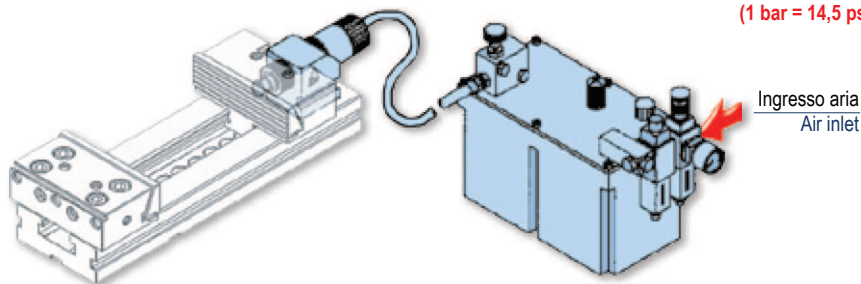
 Pressione uscita olio bar / Oil outlet pressure bar  
 (1 bar = 14,5 psi)

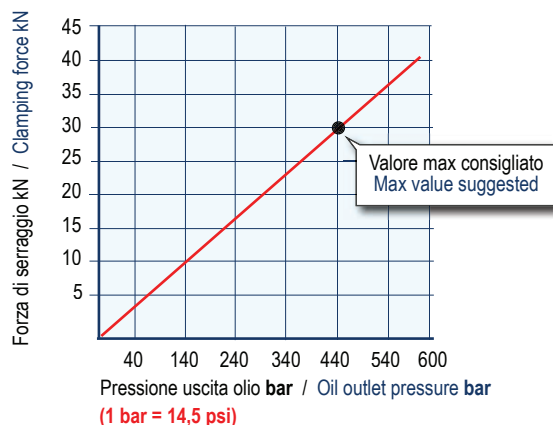
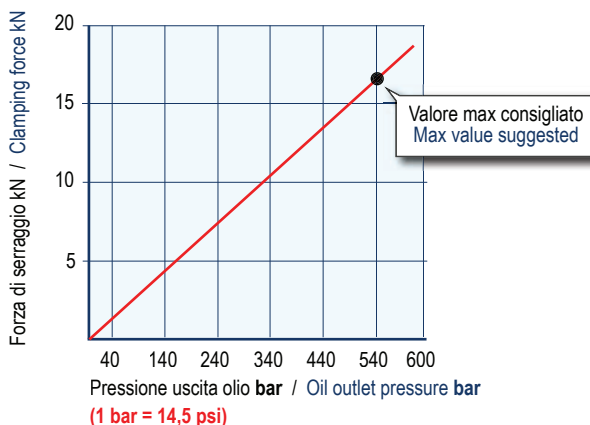
 Con centralina elettroidraulica Art. 266 - 267 - 502 - 503  
 With motor driven hydraulic power unit Art. 266 - 267 - 502 - 503

 Con centralina elettroidraulica Art. 266 - 267 - 502 - 503  
 With motor driven hydraulic power unit Art. 266 - 267 - 502 - 503

 NB: Alcuni fattori, come la lubrificazione, lo staffaggio, gli attriti ed altro, possono modificare i valori indicati fino a ± 10%.  
 Per un corretto utilizzo non superare i valori indicati nel grafico

Some factor as lubrication, clamping on the machine table, frictions and more can modify above values within a ± 10% range. For optimum operation do not exceed chart values.

**SERRAGGIO IDRAULICO**

**HYDRAULIC CLAMPING**

TRAMITE GRUPPI DI SERRAGGIO PNEUMATICI E OLEODINAMICI

I diagrammi seguenti consentono di determinare le forze di serraggio ottenibili con le morse di varia grandezza (da 1 a 6), provvisti di vari dispositivi di bloccaggio idraulici, in funzione della pressione dei fluidi (aria e olio)

THROUGH PNEUMO-HYDRAULIC AND HYDRAULIC CLAMPING DEVICES

The following diagrams give the clamping force that can be obtained with each vise type (size 1 to 6) when equipped with hydraulic blocking devices, as a function of the fluid pressure (air or oil)

**MORSE MODULARI TIPO 5**  
**MODULAR VISES TYPE 5**

Cilindro idraulico Art. 285 - 568 - 569  
Ø interno 40 mm - Superficie efficace 12,5 cm<sup>2</sup>  
Hydraulic cylinder Art. 285 - 568 - 569  
Cylinder I.D. 40 mm - Effective area 12.5 cm<sup>2</sup>

Con moltiplicatore di pressione Art. 393 (Tipo 450)  
With pressure multiplier Art.393 (Type 450)

Pressione entrata aria bar / Air inlet pressure bar

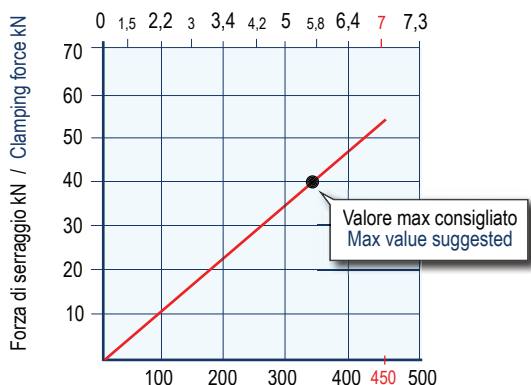

Pressione uscita olio bar / Oil outlet pressure bar  
(1 bar = 14,5 psi)

**MORSE MODULARI TIPO 6**  
**MODULAR VISES TYPE 6**

Cilindro idraulico Art. 285 - 568 - 569  
Ø interno 50 mm - Superficie efficace 19,6 cm<sup>2</sup>  
Hydraulic cylinder Art. 285 - 568 - 569  
Cylinder I.D. 50 mm - Effective area 19.6 cm<sup>2</sup>

Con moltiplicatore di pressione Art. 393 (Tipo 450)  
With pressure multiplier Art.393 (Type 450)

Pressione entrata aria bar / Air inlet pressure bar

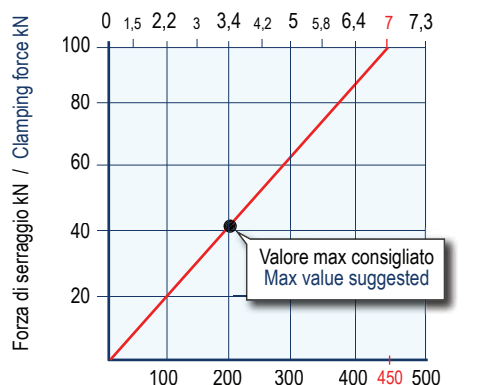

Pressione uscita olio bar / Oil outlet pressure bar  
(1 bar = 14,5 psi)

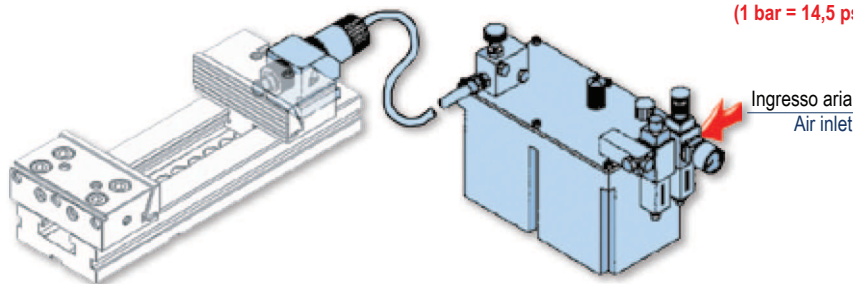

Con centralina elettroidraulica Art. 266 - 267 - 502 - 503  
With motor driven hydraulic power unit Art. 266 - 267 - 502 - 503

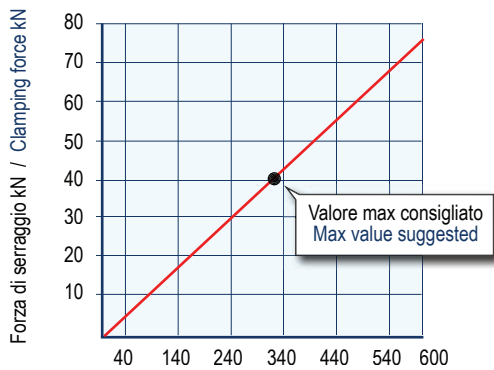

Pressione uscita olio bar / Oil outlet pressure bar  
(1 bar = 14,5 psi)

Con centralina elettroidraulica Art. 266 - 267 - 502 - 503  
With motor driven hydraulic power unit Art. 266 - 267 - 502 - 503

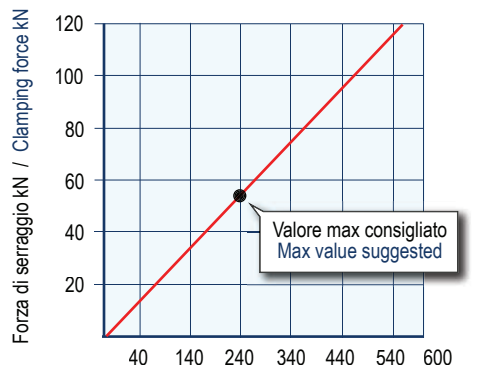

Pressione uscita olio bar / Oil outlet pressure bar  
(1 bar = 14,5 psi)

NB: Alcuni fattori, come la lubrificazione, lo staffaggio, gli attriti ed altro, possono modificare i valori indicati fino a ± 10%.  
Per un corretto utilizzo non superare i valori indicati nel grafico

Some factor as lubrication, clamping on the machine table, frictions and more can modify above values within a ± 10% range. For optimum operation do not exceed chart values.